

Serie L-IVE

APLICACIONES:

Electrobombas centrífugas con bocas en línea, adecuadas para sistemas de recirculación de agua, calefacción, aire acondicionado, recuperación de calor, instalaciones de abastecimiento hídrico, grupos de presurización e instalaciones contra incendio. Equipadas con variador de frecuencia en el motor. Bombas y motores son conformes a la directiva 2009/125/CE (ErP).

CARACTERÍSTICAS:

- | | |
|---|--|
| - Cuerpo de bomba: | Fundición esferoidal |
| - Impulsor: | Latón/Fundición
Inox. AISI-316*/Bronce* |
| - Disco portacierre: | Fundición esferoidal |
| - Eje: | Inox Aisi-431 |
| - Cierre mecánico: | Carbón-Silicio-FPM |
| - Caudal máx. [m ³ /h]: | 205 |
| - Altura máx. [m]: | 96 |
| - T° máx. Fluido [°C]: | -15 / +140 |
| - T° máx. Ambiente [°C]: | -10 / +40 |
| - Contenido máx. sólidos [g/m ³]: | 85 |
| - Rpm: | 1450 / 2900 |
| - Aislamiento: | F |
| - Protección: | IP55 |
| - Tensión de entrada: | 3x220 a 460V - 50-60 Hz |
- Funciones principales del variador de frecuencia:
- Funcionamiento a presión constante (control PID).
 - Funcionamiento a presión diferencial constante (Pd-Ps).
 - Funcionamiento a velocidad fija.
 - Funcionamiento multi-bomba en modo maestro-esclavo.
 - Control de la presión absoluta en aspiración.
 - Temperatura constante.



*Bajo demanda.

MODELO/CARACTERÍSTICAS

2900 RPM

L-IVE-2P 25-90

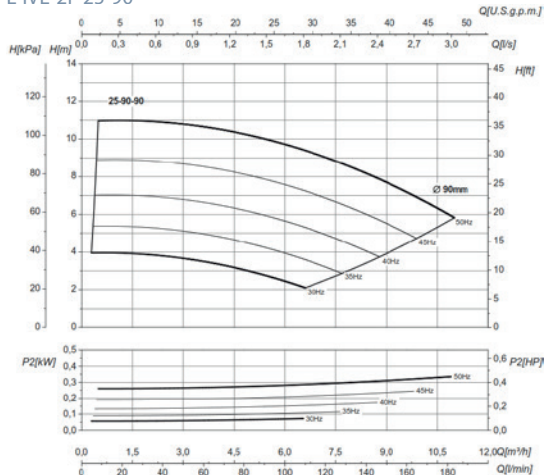

L-IVE-2P 32-100

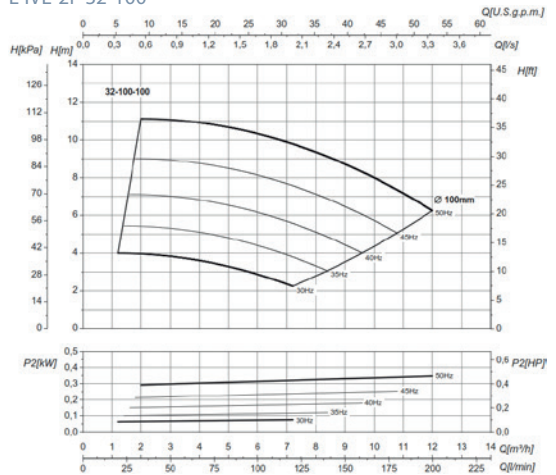

Serie L-IVE

L-IVE-2P 32-112

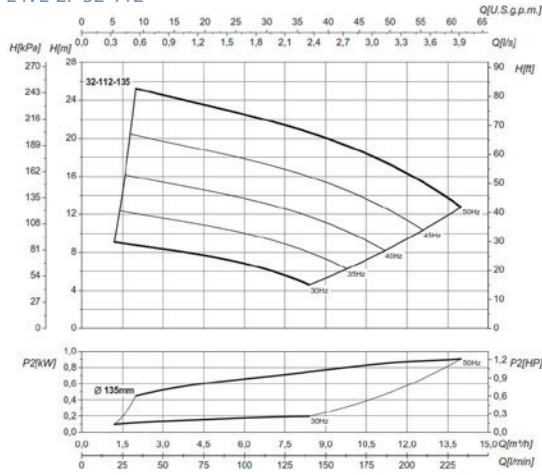

L-IVE-2P 32-125S

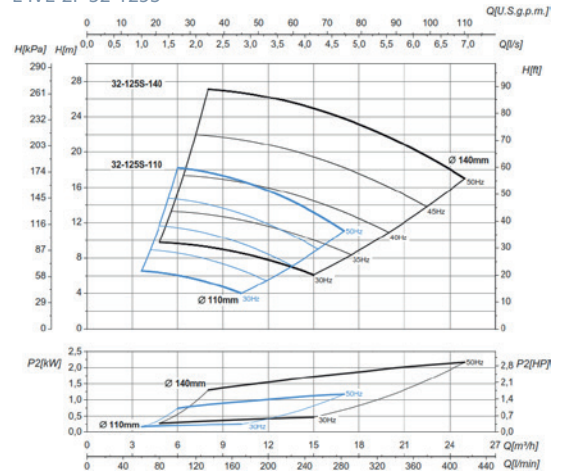

L-IVE-2P 32-160

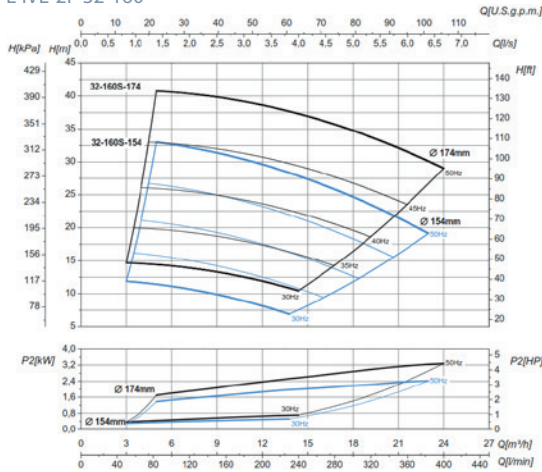

L-IVE-2P 32-200N

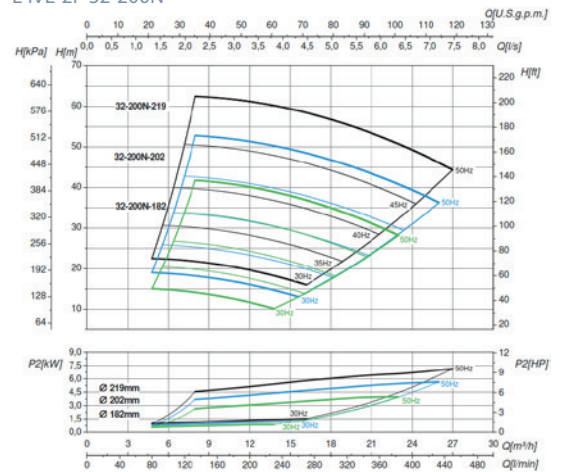

L-IVE-2P 32-250S

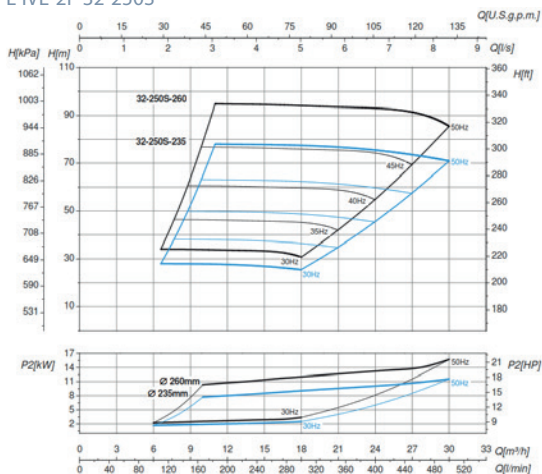

L-IVE-2P 40-100

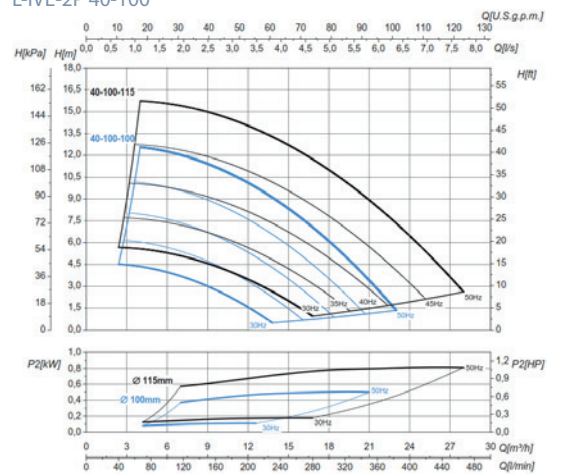

Serie L-IVE

L-IVE-2P 40-112

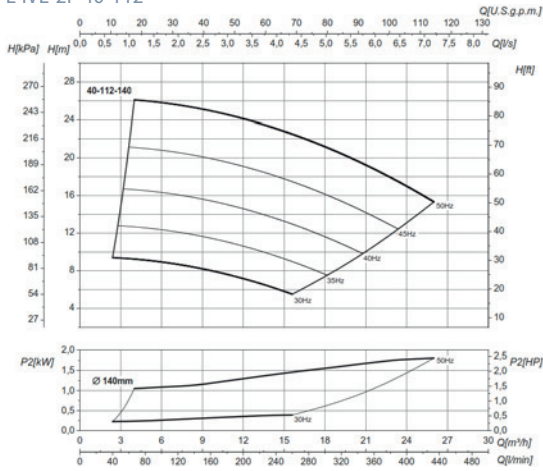

L-IVE-2P 40-125S

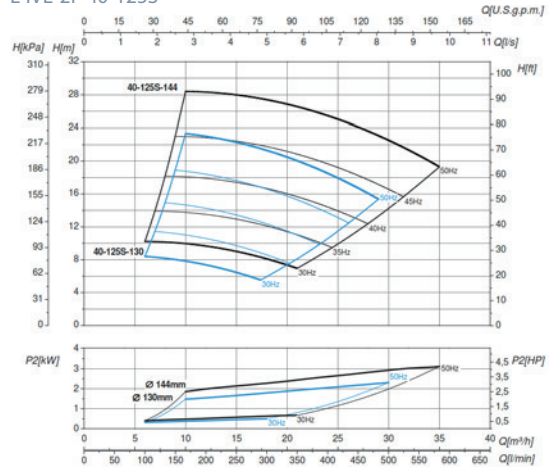

L-IVE-2P 40-160N

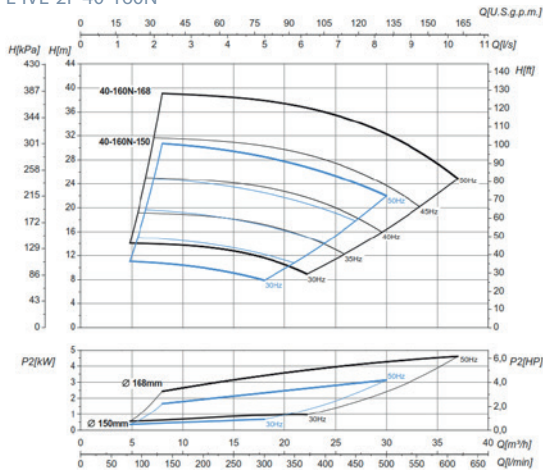

L-IVE-2P 40-200N

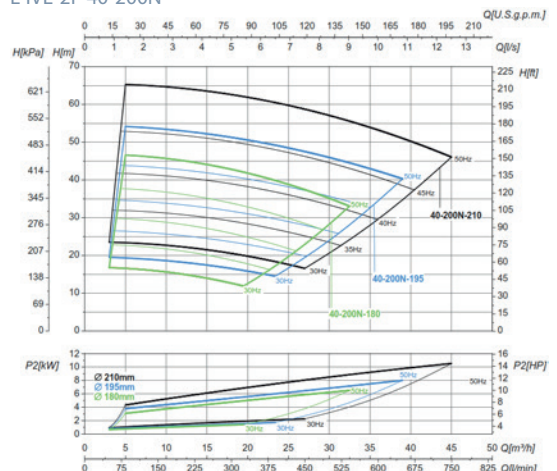

L-IVE-2P 40-250N

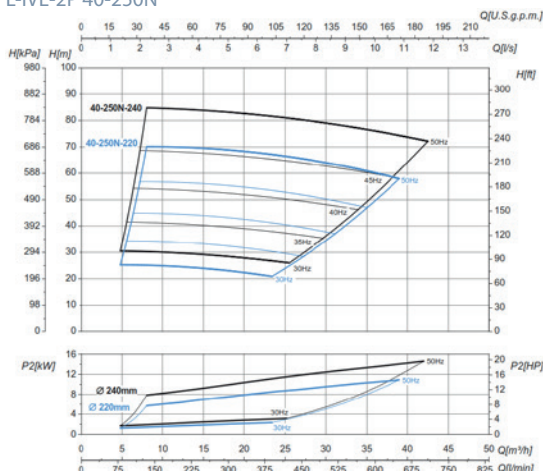

L-IVE-2P 50-112

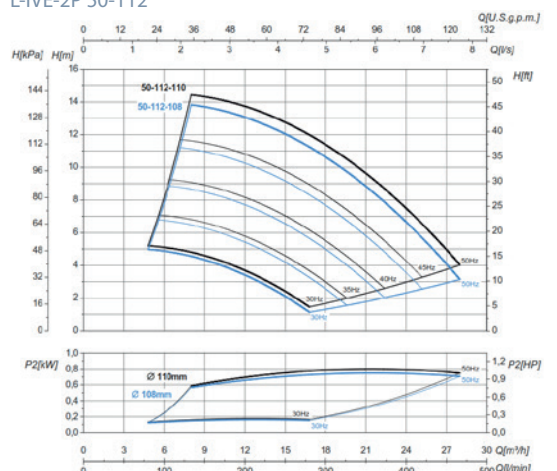

Serie L-IVE

L-IVE-2P 50-125

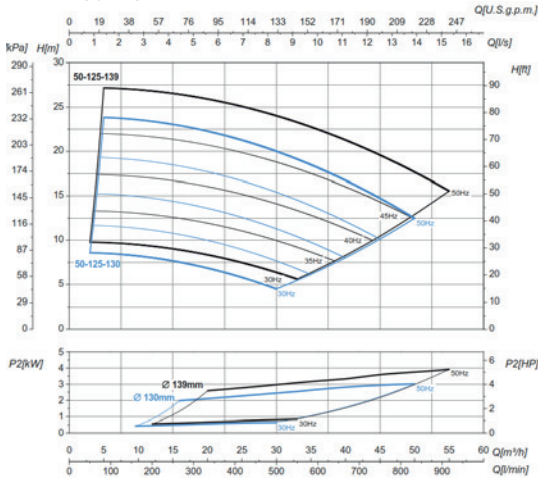

L-IVE-2P 50-160N

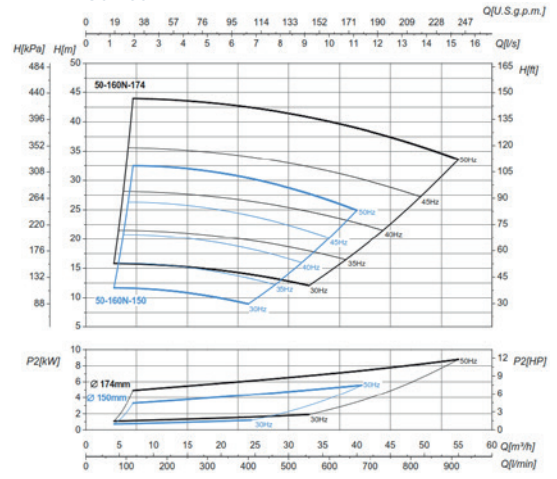

L-IVE-2P 50-200S

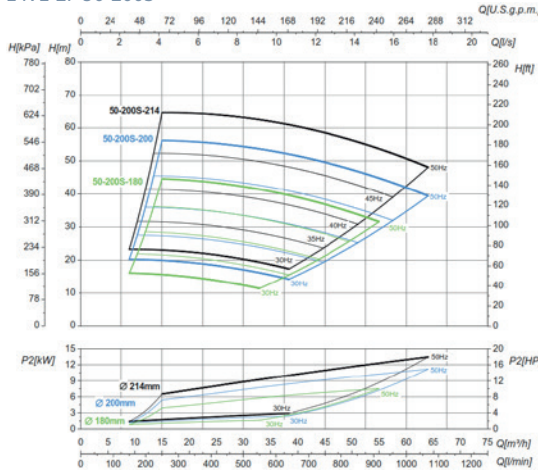

L-IVE-2P 50-250N

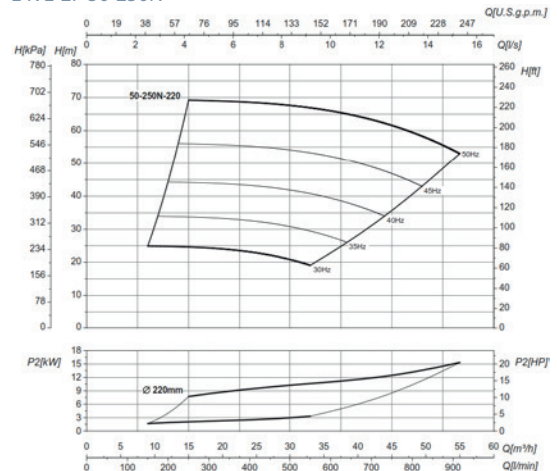

L-IVE-2P 65-112

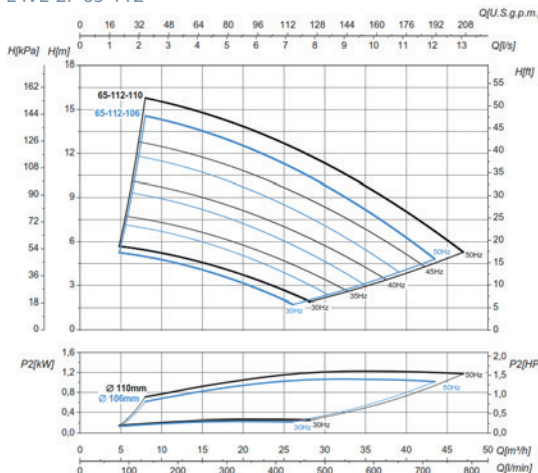

L-IVE-2P 65-125

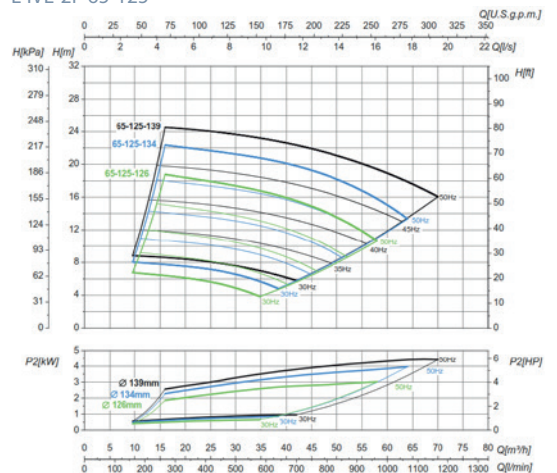

Serie L-IVE

L-IVE-2P 65-125S

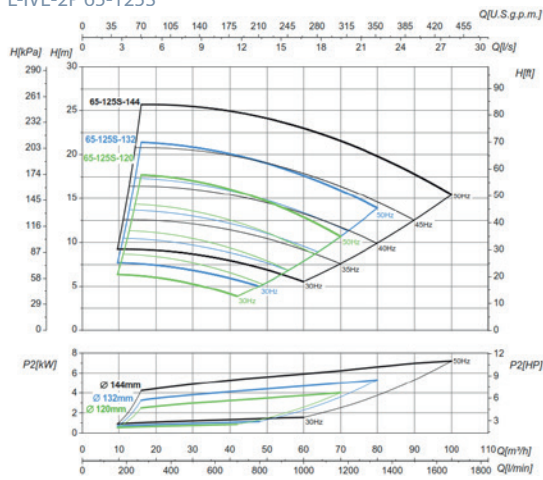

L-IVE-2P 65-160

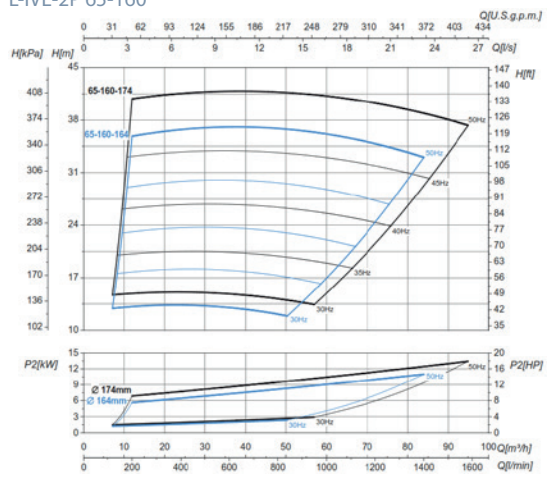

L-IVE-2P 65-200N

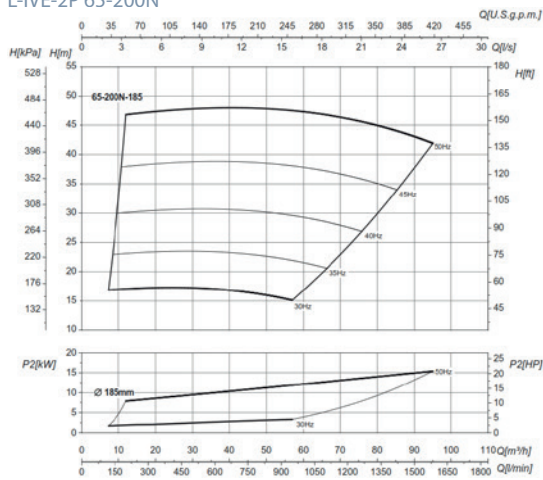

L-IVE-2P 80-125

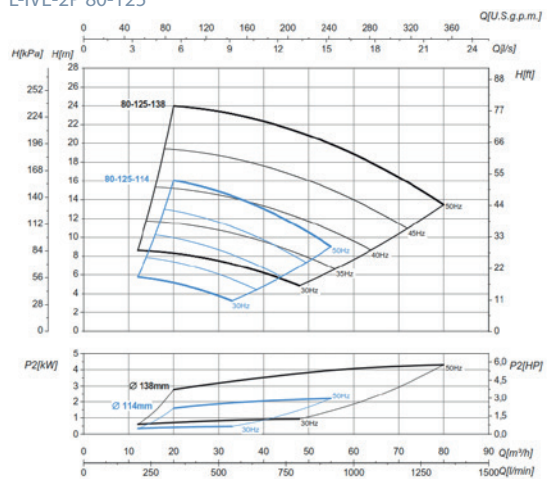

L-IVE-2P 80-160

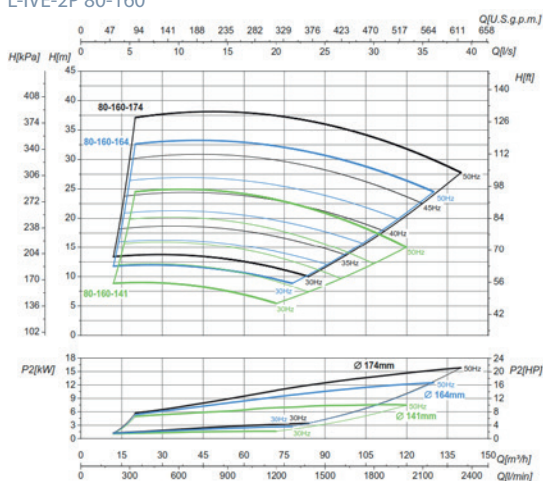

L-IVE-2P 100-125

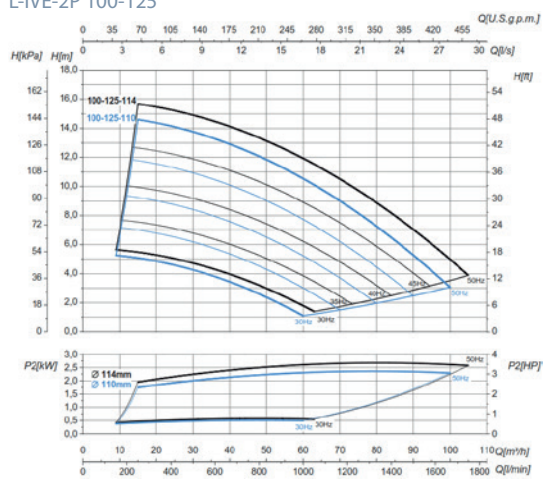

Serie L-IVE

L-IVE-2P 100-160

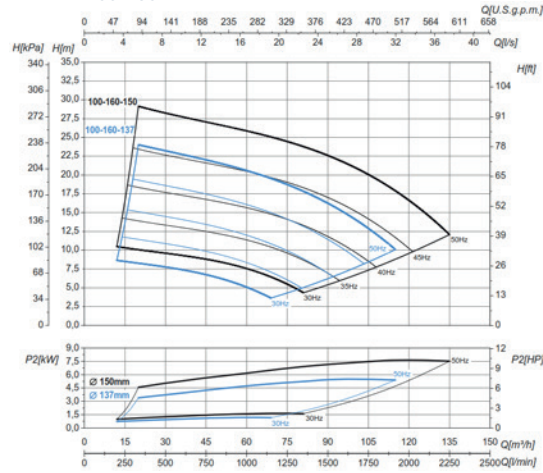

1450 RPM

L-IVE-4P 32-125S

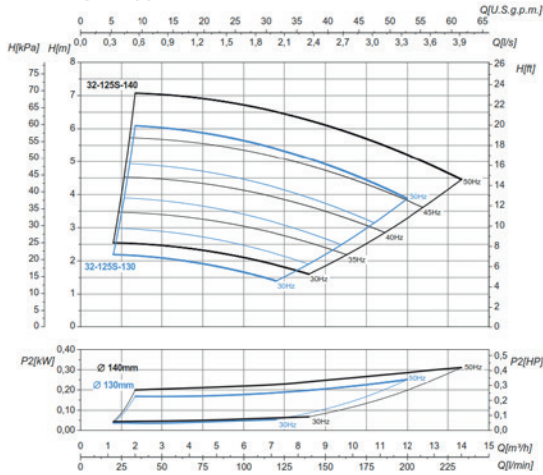

L-IVE-4P 32-160S

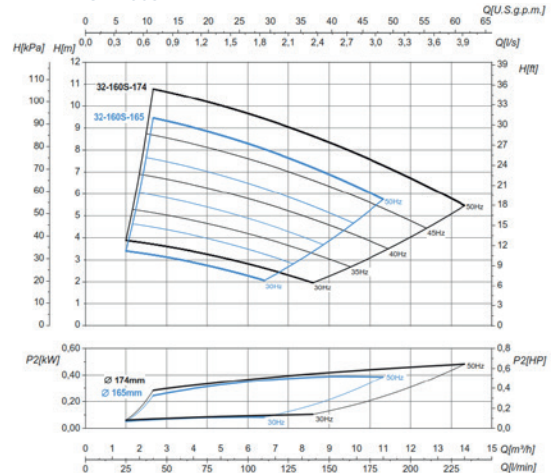

L-IVE-4P 32-200N

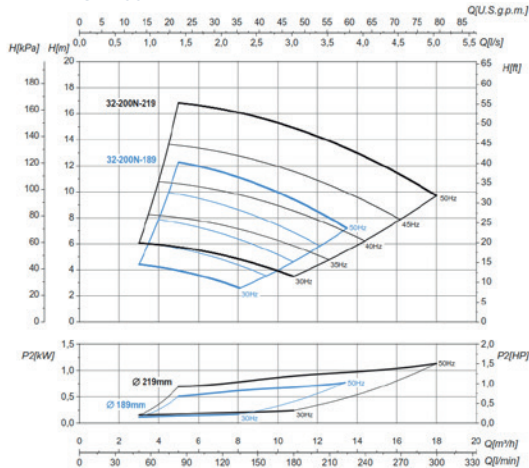

L-IVE-4P 32-250S

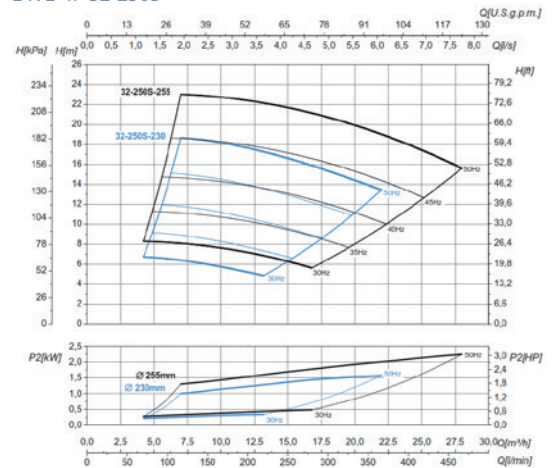

Serie L-IVE

L-IVE-4P 40-125S

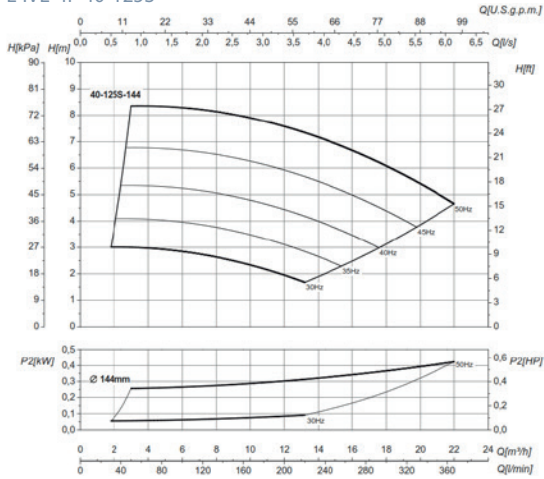

L-IVE-4P 40-160N

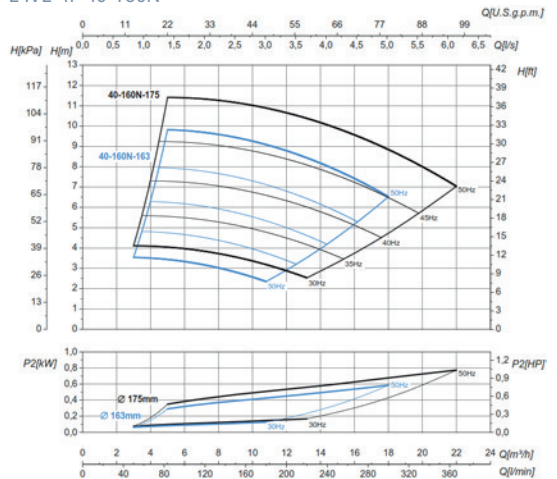

L-IVE-4P 40-200N

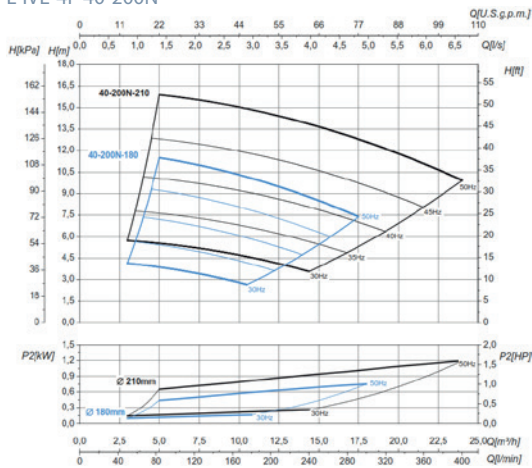

L-IVE-4P 40-250N

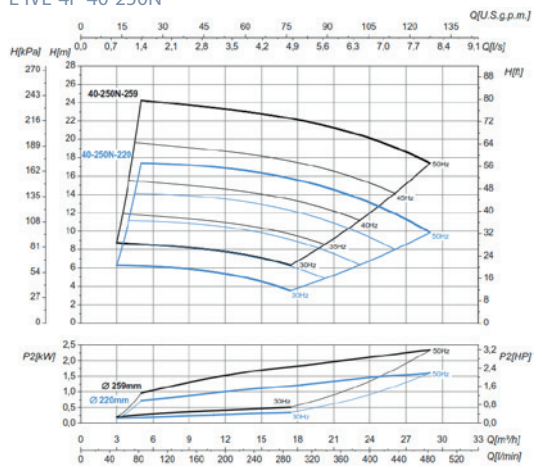

L-IVE-4P 50-125

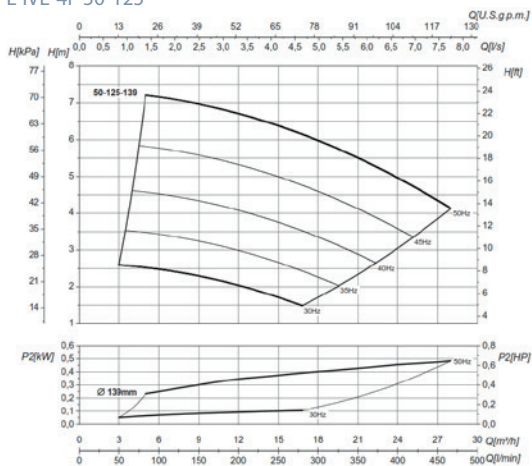

L-IVE-4P 50-160N

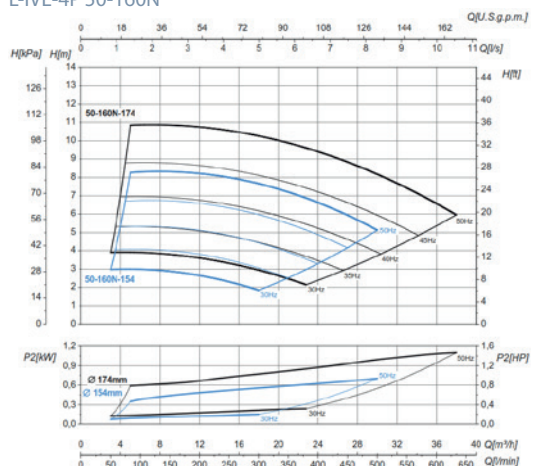

Serie L-IVE

L-IVE-4P 50-200S

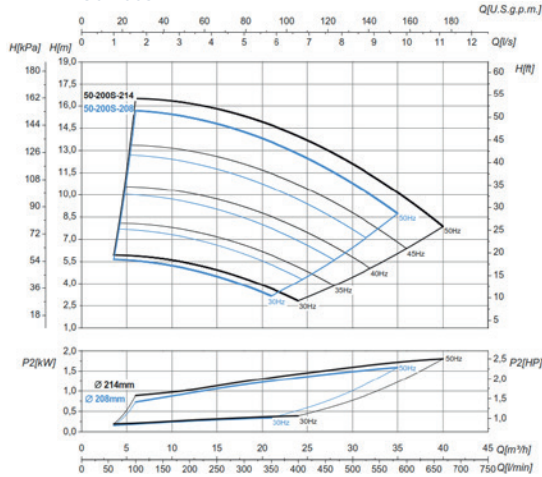

L-IVE-4P 50-250N

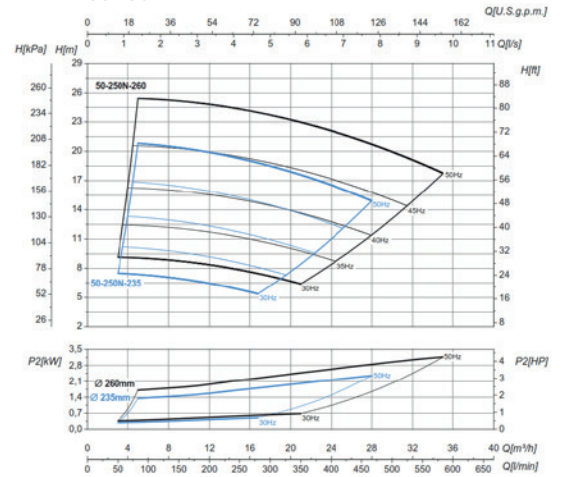

L-IVE-4P 65-125S

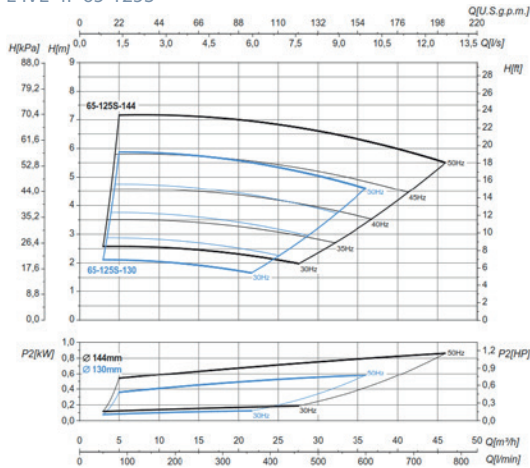

L-IVE-4P-65-160N

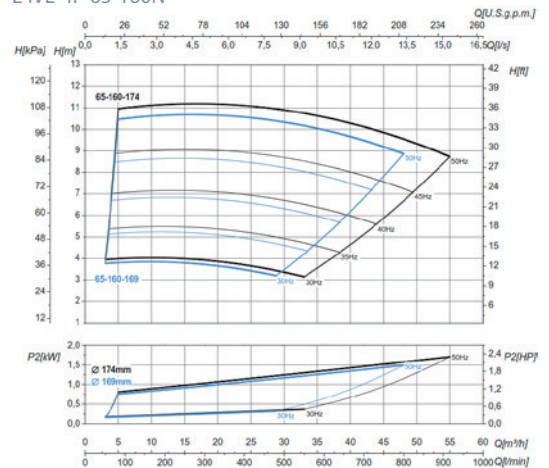

L-IVE-4P 65-200N

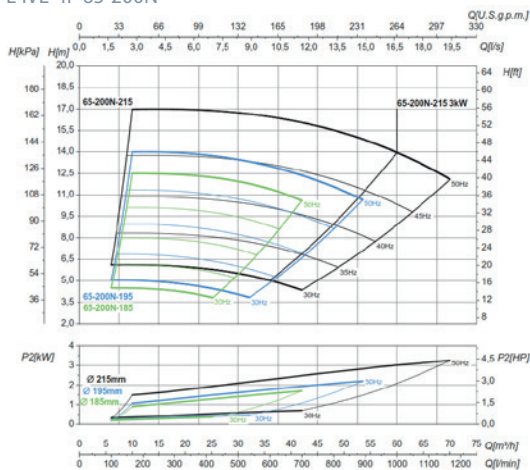

L-IVE-4P 65-250S

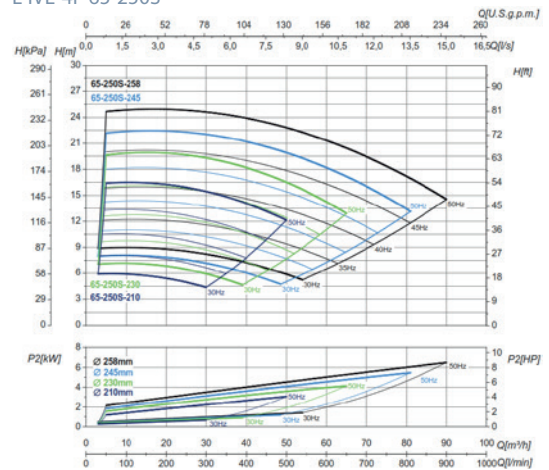

Serie L-IVE

L-IVE-4P 80-160

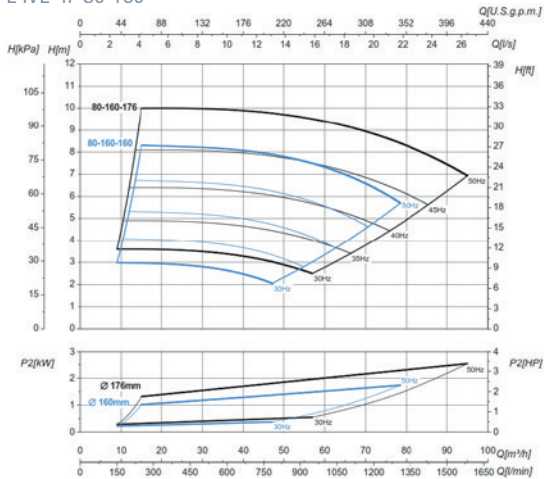

L-IVE-4P 80-200

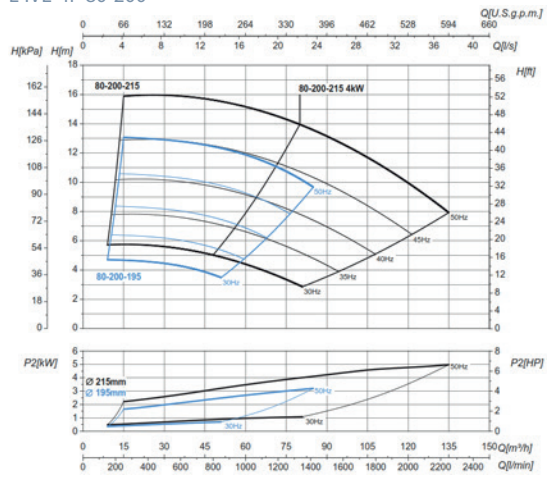

L-IVE-4P 80-250

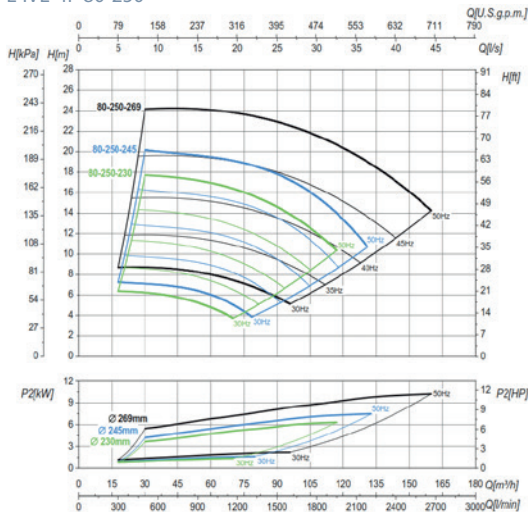

L-IVE-4P 80-315

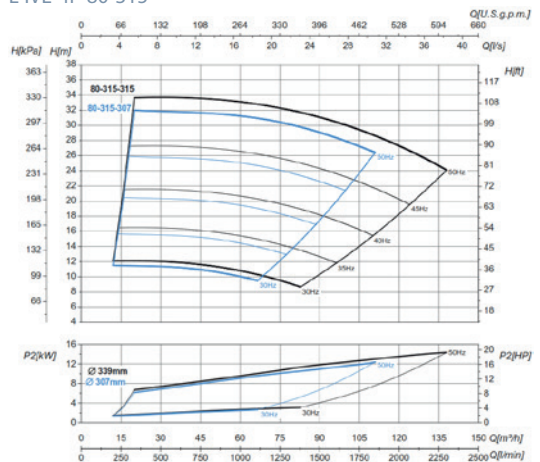

L-IVE-4P 100-200

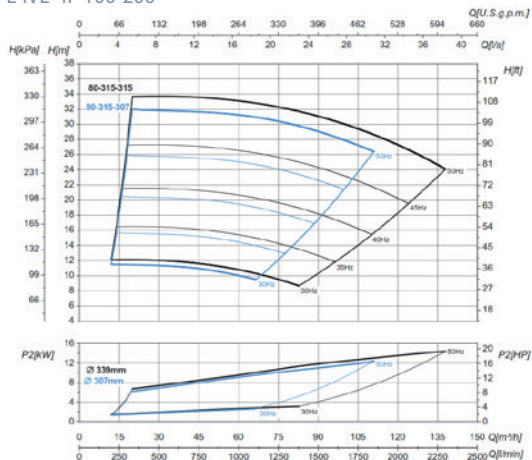

L-IVE-4P 100-250

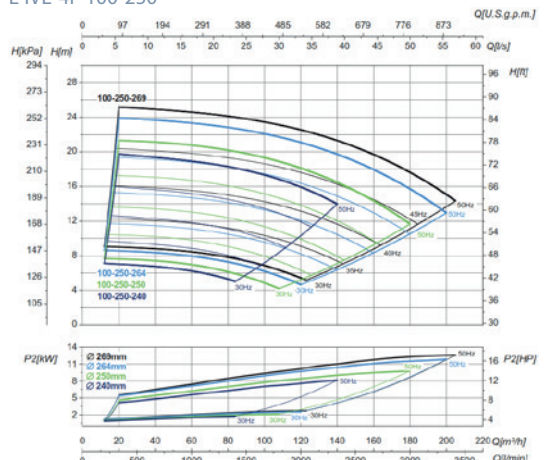

CENTRÍFUGAS EN LÍNEA CON VARIADOR INCORPORADO

Serie L-IVE

DIMENSIONES Y PESOS

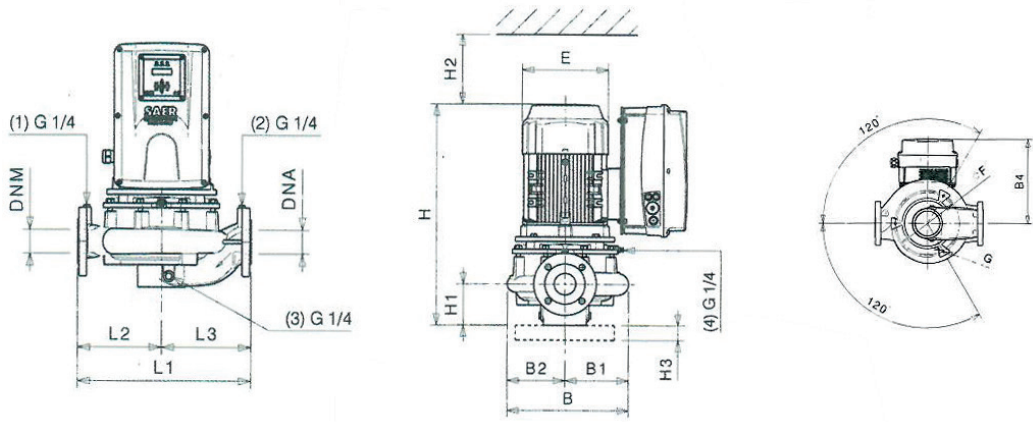

Tipo	P		MEC motor	E [mm]	L1 [mm]	L2 [mm]	L3 [mm]	H [mm]	H1 [mm]	H2 [mm]	H3 [mm]	B [mm]	B1 [mm]	B2 [mm]	B4 [mm]	F [mm]	G	DNA / DNM					
	KW	H.P.																D	K	C	DN	Agujeros ø°	η ³
L-IVE-2P 25-90-90	0,37	0,5	63	125	180	85	95	295	46	100	-	137	69	68	171	-	-	1"1/2					
L-IVE-2P 32-100-100	0,37	0,5	71	140	220	105	115	384	79	85	-	164	82	82	178	-	-						
L-IVE-2P 32-112-135	1,1	1,5	80	160	280	140	140	414	79	120	-	212	106	106	194	-	-						
L-IVE-2P 32-1255-110	1,1	1,5	80	160	280	140	140	414	79	120	-	212	106	106	194	-	-						
L-IVE-2P 32-1255-140	2,2	3	90	176	280	140	140	450	79	120	-	212	106	106	194	-	-						
L-IVE-2P 32-1605-154	2,2	3	90	176	340	160	180	471	100	110	-	238	119	119	194	-	-						
L-IVE-2P 32-1605-174	3	4	100	196	340	160	180	561	100	110	-	238	119	119	250	-	-	144	100	78	32	18	4
L-IVE-2P 32-200N-182	4	5,5	112	220	440	180	260	543	100	130	-	286	143	143	212	-	-						
L-IVE-2P 32-200N-202	5,5	7,5	132	260	440	180	260	609	100	130	-	286	143	143	291	-	-						
L-IVE-2P 32-200N-219	7,5	10	132	260	440	180	260	609	100	130	-	286	143	143	370	-	-						
L-IVE-2P 32-2505-235	11	15	132	260	490	240	250	619	110	110	40	337	171	166	370	290	M12						
L-IVE-2P 32-2505-260	15	20	132	260	490	240	250	674	110	110	40	337	171	166	370	290	M12						
L-IVE-2P 40-100-100	0,55	0,75	71	140	250	120	130	390	79	140	-	194	99	95	178	-	-						
L-IVE-2P 40-100-115	1,1	1,5	80	160	250	120	130	440	79	140	-	194	99	95	194	-	-						
L-IVE-2P 40-112-140	2,2	3	90	176	320	140	180	449	79	120	40	221	113	108	194	168	M10						
L-IVE-2P 40-1255-130	2,2	3	90	176	320	140	180	449	79	120	40	221	113	108	194	168	M10						
L-IVE-2P 40-1255-140	3	4	100	196	320	140	180	539	79	120	40	221	113	108	250	168	M10						
L-IVE-2P 40-160N-150	3	4	100	196	340	160	180	559	100	80	40	242	122	120	250	168	M10	154	110	88	40	18	4
L-IVE-2P 40-160N-168	5,5	7,5	132	260	340	160	180	615	100	80	40	242	122	120	291	168	M10						
L-IVE-2P 40-200N-180	5,5	7,5	132	260	440	180	260	619	110	130	40	286	143	143	370	190	M10						
L-IVE-2P 40-200N-195	7,5	10	132	260	440	180	260	619	110	130	40	286	143	143	370	190	M10						
L-IVE-2P 40-200N-210	11	15	132	260	440	180	260	619	110	130	40	286	143	143	370	190	M10						
L-IVE-2P 40-250N-220	11	15	132	260	490	240	250	620	110	130	40	332	166	166	370	190	M10						
L-IVE-2P 40-250N-240	15	20	132	260	490	240	250	675	110	130	40	332	166	166	370	190	M10						
L-IVE-2P 50-112-108	0,75	1	80	160	280	130	150	461	100	140	-	192	97	95	194	-	-						
L-IVE-2P 50-112-110	1,1	1,5	80	160	280	130	150	461	100	140	-	192	97	95	194	-	-						
L-IVE-2P 50-125-130	3	4	100	196	340	160	180	539	115	100	40	238	128	110	212	180	M10						
L-IVE-2P 50-125-139	4	5,5	112	220	340	160	180	575	115	100	40	238	128	110	250	180	M10						
L-IVE-2P 50-160N-150	5,5	7,5	132	260	340	160	180	629	115	130	40	263	140	123	291	200	M10	169	125	102	50	18	4
L-IVE-2P 50-160N-174	9,2	12,5	132	260	340	160	180	629	115	130	40	263	140	123	291	200	M10						
L-IVE-2P 50-2005-180	7,5	10	132	260	440	200	240	625	115	110	40	299	153	146	370	190	M10						
L-IVE-2P 50-2005-200	11	15	132	260	440	200	240	625	115	110	40	299	153	146	370	190	M10						
L-IVE-2P 50-2005-214	15	20	132	260	440	200	240	680	115	110	40	299	153	146	370	190	M10						
L-IVE-2P 50-250N-220	15	20	132	260	440	215	225	680	115	140	40	339	173	166	370	290	M12						



CENTRÍFUGAS EN LÍNEA CON VARIADOR INCORPORADO



Serie L-IVE

Tipo	P		MEC motor	E [mm]	L1 [mm]	L2 [mm]	L3 [mm]	H [mm]	H1 [mm]	H2 [mm]	H3 [mm]	B [mm]	B1 [mm]	B2 [mm]	B4 [mm]	F [mm]	G	DNA / DNM					
	kW	H.P.																D	K	C	DN	Agujeros ø° n°	
L-IVE-2P 65-112-106	1,1	1,5	80	160	340	160	180	466	105	140	40	204	109	95	194	164	M10						
L-IVE-2P 65-112-110	1,5	2	90	176	340	160	180	501	105	140	40	204	109	95	194	164	M10						
L-IVE-2P 65-125-126	3	4	100	196	360	160	200	529	105	130	40	261	146	115	212	180	M10						
L-IVE-2P 65-125-134	4	5,5	112	220	360	160	200	565	105	130	40	261	146	115	250	180	M10						
L-IVE-2P 65-125-139	5,5	7,5	132	260	360	160	200	621	105	130	40	261	146	115	370	180	M10						
L-IVE-2P 65-1255-120	4	5,5	112	220	360	160	200	565	105	130	40	261	146	115	212	180	M10	189	145	122	65	18	4
L-IVE-2P 65-1255-132	5,5	7,5	132	260	360	160	200	621	105	130	40	261	146	115	291	180	M10						
L-IVE-2P 65-1255-144	7,5	10	132	260	360	160	200	621	105	130	40	261	146	115	370	180	M10						
L-IVE-2P 65-160-164	11	15	132	260	360	160	200	624	105	150	40	275	150	125	370	200	M10						
L-IVE-2P 65-160-174	15	20	132	260	360	160	200	679	105	150	40	275	150	125	370	200	M10						
L-IVE-2P 65-200N-185	15	20	160	310	475	225	250	767	125	140	40	321	171	150	404	250	M12						
L-IVE-2P 80-125-114	2,2	3	90	176	360	180	180	587	115	110	40	247	138	109	194	180	M10						
L-IVE-2P 80-125-138	4	5,5	112	220	360	180	180	637	115	110	40	247	138	109	212	180	M10						
L-IVE-2P 80-160-141	7,5	10	132	260	440	210	230	735	115	120	40	309	173	136	370	200	M10	204	160	138	85	18	8
L-IVE-2P 80-160-164	11	15	132	260	440	210	230	735	115	120	40	309	173	136	370	200	M10						
L-IVE-2P 80-160-174	15	20	132	260	440	210	230	790	115	120	40	309	173	136	370	200	M10						
L-IVE-2P 100-125-110	2,2	3	90	176	450	210	240	596	125	110	40	257	142	115	194	168	M10						
L-IVE-2P 100-125-114	3	4	100	196	450	210	240	682	125	110	40	257	142	115	250	168	M10						
L-IVE-2P 100-160-137	5,5	7,5	112	220	500	240	260	680	140	115	40	283	159	124	212	200	M10	230	180	158	100	18	8
L-IVE-2P 100-160-150	7,5	10	132	260	500	240	260	780	140	115	40	283	159	124	370	200	M10						
L-IVE-4P 32-1255-130	0,25	0,33	71	140	280	140	140	380	79	140	-	212	106	106	178	-	-						
L-IVE-4P 32-1255-140	0,37	0,5	80	160	280	140	140	414	79	120	-	212	106	106	194	-	-						
L-IVE-4P 32-1605-165	0,37	0,5	80	160	340	160	180	436	100	110	-	238	119	119	194	-	-						
L-IVE-4P 32-1605-174	0,55	0,75	80	160	340	160	180	471	100	110	-	238	119	119	194	-	-						
L-IVE-4P 32-200N-189	0,75	1	80	160	440	180	260	473	100	130	-	286	143	143	194	-	-	144	100	78	32	18	4
L-IVE-4P 32-200N-219	1,1	1,5	90	176	440	180	260	471	100	130	-	286	143	143	194	-	-						
L-IVE-4P 32-2505-230	1,5	2	90	176	490	240	250	516	110	110	40	337	171	166	194	290	M12						
L-IVE-4P 32-2505-255	2,2	3	100	196	490	240	250	566	110	110	40	337	171	166	255	290	M12						
L-IVE-4P 40-1255-144	0,55	0,75	80	160	320	140	180	414	79	120	40	221	113	108	194	168	M10						
L-IVE-4P 40-160N-163	0,55	0,75	80	160	340	160	180	436	100	80	40	242	122	120	194	164	M10						
L-IVE-4P 40-160N-175	0,75	1	80	160	340	160	180	471	100	80	40	242	122	120	194	164	M10						
L-IVE-4P 40-200N-180	0,75	1	80	160	440	180	260	483	110	130	40	286	143	143	194	190	M10	154	110	88	40	18	4
L-IVE-4P 40-200N-210	1,1	1,5	80	176	440	180	260	481	110	130	40	286	143	143	194	190	M10						
L-IVE-4P 40-250N-220	1,1	1,5	90	176	490	240	250	489	110	130	40	332	166	166	194	190	M10						
L-IVE-4P 40-250N-259	2,2	3	100	196	490	240	250	566	110	130	40	332	166	166	255	190	M10						
L-IVE-4P 50-125-220	0,55	0,75	80	160	340	160	180	485	115	100	40	238	128	110	194	180	M10						
L-IVE-4P 50-160N-154	0,75	1	80	160	340	160	180	488	115	130	40	263	140	123	194	200	M10						
L-IVE-4P 50-160N-174	1,1	1,5	90	176	340	160	180	486	115	130	40	263	140	123	194	200	M10						
L-IVE-4P 50-2005-208	1,5	2	90	176	440	200	240	518	115	110	40	299	153	146	194	190	M10	169	125	102	50	18	4
L-IVE-4P 50-2005-214	2,2	3	100	196	440	200	240	576	115	110	40	299	153	146	255	190	M10						
L-IVE-4P 50-250N-235	2,2	3	100	196	440	215	225	571	115	140	40	339	173	166	255	290	M12						
L-IVE-4P 50-250N-260	3	4	100	196	440	215	225	571	115	140	40	339	173	166	250	290	M12						
L-IVE-4P 65-1255-130	0,55	0,75	80	160	360	160	200	444	105	130	40	261	146	115	194	180	M10						
L-IVE-4P 65-1255-144	1,1	1,5	90	176	360	160	200	478	105	130	40	261	146	115	194	180	M10						
L-IVE-4P 65-160N-169	1,5	2	90	176	360	160	200	510	105	150	40	275	150	125	194	200	M10						
L-IVE-4P 65-160N-174	2,2	3	100	196	360	160	200	566	105	150	40	275	150	125	255	200	M10						
L-IVE-4P 65-200N-185	1,5	2	90	176	475	225	250	530	125	140	40	321	171	150	194	250	M12	189	145	122	65	18	4
L-IVE-4P 65-200N-195	2,2	3	100	196	475	225	250	586	125	140	40	321	171	150	255	250	M12						
L-IVE-4P 65-200N-215	3	4	100	196	475	225	250	586	125	140	40	321	171	150	250	250	M12						
L-IVE-4P 65-200N-215	4	5,5	112	220	475	225	250	573	125	140	40	321	171	150	212	250	M12						
L-IVE-4P 65-2505-210	3	4	100	196	475	230	245	610	125	170	40	367	192	175	212	280	M12						



CENTRÍFUGAS EN LÍNEA CON VARIADOR INCORPORADO

Serie L-IVE

Tipo	P		MEC motor	E [mm]	L1 [mm]	L2 [mm]	L3 [mm]	H [mm]	H1 [mm]	H2 [mm]	H3 [mm]	B [mm]	B1 [mm]	B2 [mm]	B4 [mm]	F [mm]	G	DNA / DNM											
	kW	H.P.																D	K	C	DN	Agujeros ø° n°							
L-IVE-4P 65-2505-230	4	5,5	112	220	475	230	245	623	125	170	40	367	192	175	250	280	M12	189	145	122	65	18	4						
L-IVE-4P 65-2505-245	5,5	7,5	132	260	475	230	245	669	125	170	40	367	192	175	291	280	M12												
L-IVE-4P 65-2505-258	7,5	10	132	260	475	230	245	724	125	170	40	367	192	175	370	280	M12												
L-IVE-4P 80-160-160	1,5	2	90	176	440	210	230	591	115	120	40	309	173	136	194	200	M10												
L-IVE-4P 80-160-176	3	4	100	196	440	210	230	648	115	120	40	309	173	136	250	200	M10												
L-IVE-4P 80-200-195	3	4	100	196	550	250	300	703	140	160	40	359	193	166	250	230	M10												
L-IVE-4P 80-200-215	5,5	7,5	132	260	550	250	300	786	140	160	40	359	193	166	291	230	M10												
L-IVE-4P 80-250-230	5,5	7,5	132	260	620	280	340	785	140	170	40	397	209	188	291	260	M12							204	160	138	85	18	8
L-IVE-4P 80-250-245	7,5	10	132	260	620	280	340	840	140	170	40	397	209	188	370	260	M12												
L-IVE-4P 80-250-269	9,2	12,5	132	260	620	280	340	840	140	170	40	397	209	188	370	260	M12												
L-IVE-4P 80-315-307	11	15	160	310	670	305	365	951	140	150	40	468	243	225	404	320	M12												
L-IVE-4P 80-315-315	15	20	160	310	670	305	365	992	140	150	40	468	243	225	404	320	M12												
L-IVE-4P 100-200-182	3	4	100	196	550	260	290	703	140	160	40	398	214	184	250	260	M12	230	180	158	100	18	8						
L-IVE-4P 100-200-195	4	5,5	112	220	550	260	290	690	140	160	40	398	214	184	212	260	M12												
L-IVE-4P 100-200-215	5,5	7,5	132	260	550	260	290	786	140	160	40	398	214	184	291	260	M12												
L-IVE-4P 100-250-240	7,5	10	132	260	670	280	390	875	175	170	40	447	238	209	370	320	M12												
L-IVE-4P 100-250-250	9,2	12,5	132	260	670	280	390	875	175	170	40	447	238	209	370	320	M12												
L-IVE-4P 100-250-264	11	15	160	310	670	280	390	986	175	170	40	447	238	209	404	320	M12												
L-IVE-4P 100-250-269	11	15	160	310	670	280	390	986	175	170	40	447	238	209	404	320	M12												

